

## Surface Mount Schottky Barrier Rectifier

Reverse Voltage - 20 to 200 V

Forward Current - 5 A

### FEATURES

- ◆Metal silicon junction, majority carrier conduction
- ◆For surface mounted applications
- ◆Low power loss, high efficiency
- ◆High forward surge current capability
- ◆For use in low voltage, high frequency inverters, free wheeling, and polarity protection applications
- ◆Lead free in comply with EU RoHS 2011/65/EU directives

### MECHANICAL DATA

- ◆Case: SMAF
- ◆Terminals: Solderable per MIL-STD-750, Method 2026
- ◆Approx. Weight: 27mg / 0.00095oz

**Absolute Maximum Ratings and Electrical characteristics**  
 Ratings at 25 °C ambient temperature unless otherwise specified. Single phase, half wave, 60Hz resistive or inductive load, for capacitive load, derate by 20 %

### Pinning

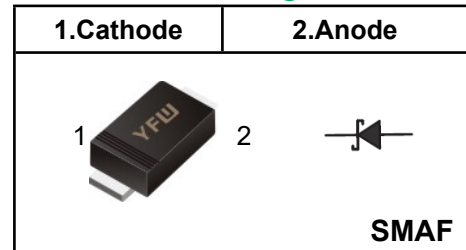

### Marking Code

<b>SS52F</b>	<b>YFW SS52</b>
<b>SS54F</b>	<b>YFW SS54</b>
<b>SS56F</b>	<b>YFW SS56</b>
<b>SS58F</b>	<b>YFW SS58</b>
<b>SS510F</b>	<b>YFW SS510</b>
<b>SS512F</b>	<b>YFW SS512</b>
<b>SS515F</b>	<b>YFW SS515</b>
<b>SS520F</b>	<b>YFW SS520</b>

Parameter	Symbols	SS52F	SS54F	SS56F	SS58F	SS510F	SS512F	SS515F	SS520F	Units		
Maximum Repetitive Peak Reverse Voltage	$V_{RRM}$	20	40	60	80	100	120	150	200	V		
Maximum RMS voltage	$V_{RMS}$	14	28	42	56	70	84	105	140	V		
Maximum DC Blocking Voltage	$V_{DC}$	20	40	60	80	100	120	150	200	V		
Maximum Average Forward Rectified Current	$I_{F(AV)}$	5.0								A		
Peak Forward Surge Current, 8.3ms Single Half Sine-wave Superimposed on Rated Load (JEDEC method)	$I_{FSM}$	120								A		
Peak Forward Surge Current, 1.0ms Single Half Sine-wave Superimposed on Rated Load (JEDEC method)	$I_{FSM}$	240								A		
$I^2t$ Rating for fusing (3ms $\leq t \leq$ 8.3ms)	$I^2t$	59.7								A <sup>2</sup> S		
Maximum Instantaneous Forward Voltage at 5 A	$V_F$	0.55	0.70	0.85	0.95					V		
Maximum Instantaneous Reverse Current at Rated DC Reverse Voltage <small><math>T_A = 25^\circ\text{C}</math> <math>T_A = 100^\circ\text{C}</math></small>	$I_R$	1.0				50				mA		
Typical Junction Capacitance <sup>(1)</sup>	$C_j$	270	220	160	100			80	pF			
Typical Thermal Resistance <sup>(2)</sup>	$R_{\theta JA}$ $R_{\theta JC}$ $R_{\theta JL}$	100				20				25		°C/W
Operating Junction Temperature Range	$T_j$	-55 ~ +150								°C		
Storage Temperature Range	$T_{stg}$	-55 ~ +150								°C		

(1) Measured at 1 MHz and applied reverse voltage of 4 V D.C

(2) P.C.B. mounted with 2.0" X 2.0" (5 X 5 cm) copper pad areas.

**Fig.1 Forward Current Derating Curve**

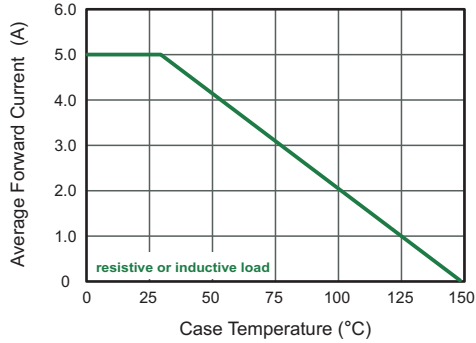

**Fig.2 Typical Reverse Characteristics**

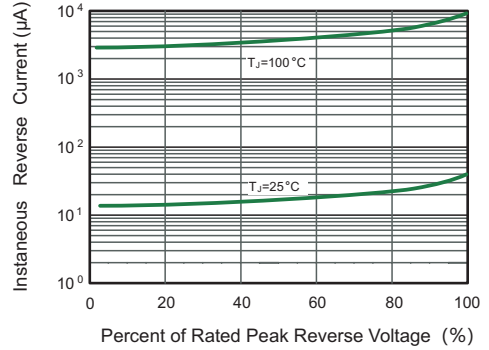

**Fig.3 Typical Forward Characteristic**

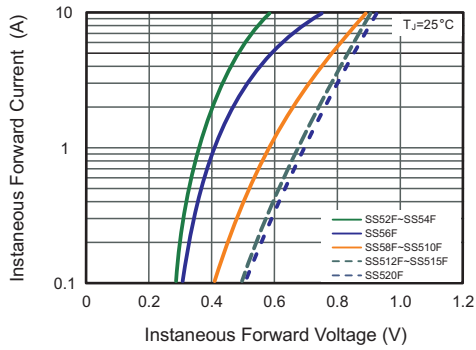

**Fig.4 Typical Junction Capacitance**

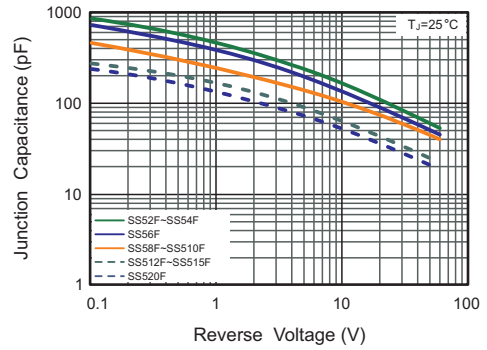

**Fig.5 Maximum Non-Repetitive Forward Surge Current**

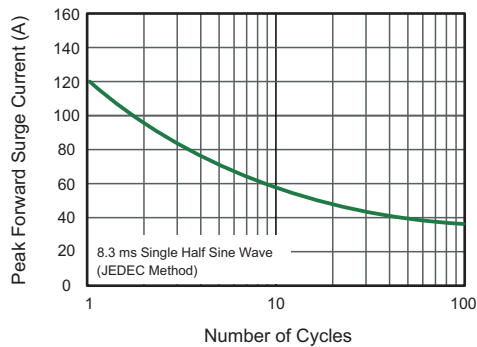

**Marking Diagram**

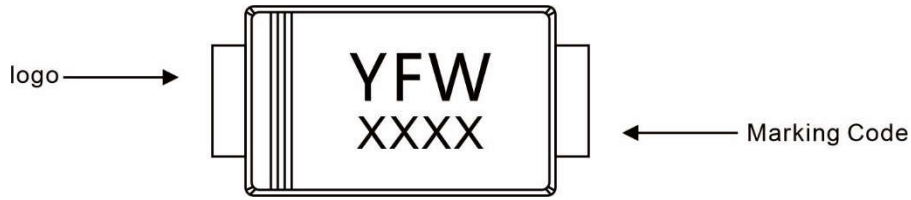

**Ordering information**

Package	Packing Description	Packing Quantity
SMAF	Tape/Reel, 7" reel	3000PCS/Reel 90000PCS/Carton

**Package Dimensions**

**SMAF**

Dim.	Millimeter(mm)		mil	
	Min.	Max.	Min.	Max.
A	0.9	1.1	35	43
C	0.12	0.20	4.7	7.9
D	3.3	3.7	130	146
E	2.4	2.7	94	106
e	1.3	1.6	51	63
g	0.8	1.2	31	47
HE	4.4	4.9	173	193
∠	7°			

**The recommended mounting pad size**

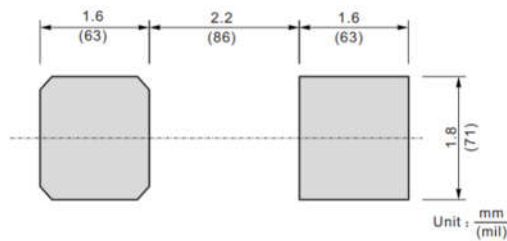

## Disclaimer

The information presented in this document is for reference only. GuangDong Youfeng Microelectronics Co.,Ltd. reserves the right to make changes without notice for the specification of the products displayed herein to improve reliability, function or design or otherwise. The product listed herein is designed to be used with ordinary electronic equipment or devices, and not designed to be used with equipment or devices which require high level of reliability and the malfunction of which would directly endanger human life (such as medical instruments, transportation equipment, aerospace machinery, nuclear-reactor controllers, fuel controllers and other safety devices), YFW or anyone on its behalf, assumes no responsibility or liability for any damages resulting from such improper use of sale. This publication supersedes & replaces all information previously supplied. For additional information, please visit our website <https://www.yfwdiode.com>, or consult YFW sales office for further assistance.